



# PHOENIX MOTOR

## Installation and Operation Instructions

### PRODUCT FEATURES & DIMENSIONS

(dimensions in parentheses are in millimeters)

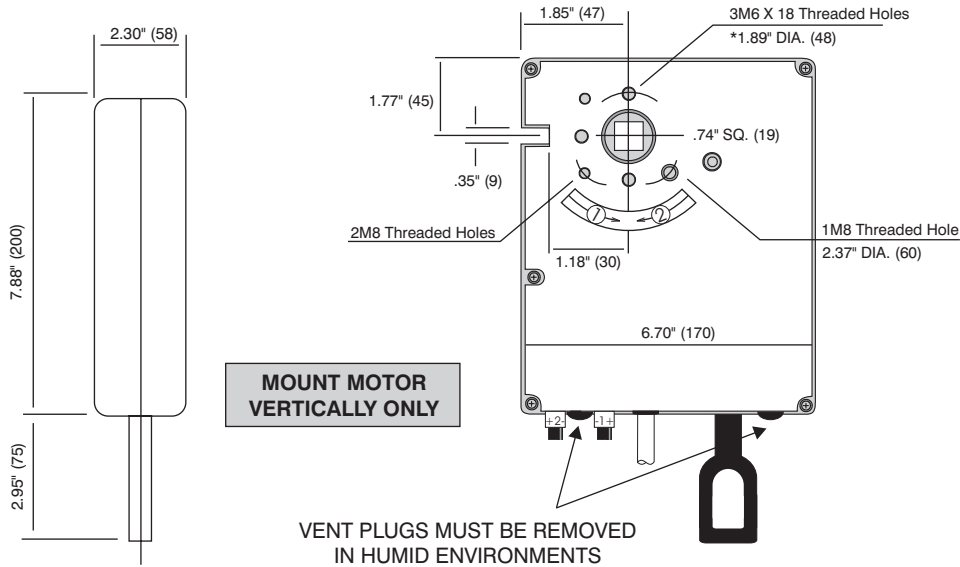

### MOTOR TYPE

Asynchronous, Single Phase - Totally enclosed

MOTOR WITH BUILT - IN START AND RUN CAPACITOR

BUILT IN BRAKE

COMPACT SILENT MOTOR WITH ANTI - CORROSION COATING FOR OUTDOOR INSTALLATION

PULL - ON MANUAL OVERRIDE ENGAGES WHEN PULLING CRANK HANDLE

BUILT - IN SAFETY POWER SWITCH IS OFF WHEN OVERRIDE IS ENGAGED

MANUAL OVERRIDE RATIO 1/26

POWER CABLE - 6'

### MOTOR SPECIFICATIONS

TYPE	TORQUE		SPEED	ELECTRICAL RATING	LIMIT SWITCH CAPACITY	WEIGHT		THEORETICAL LIFTING CAPACITY				
	IN.LBS.	MN				LB	KG	OD = 1.5"		OD = 2"		OD = 2.5"
							LB	KG	LB	KG	LB	KG
PH 50/12	440	50	12 RPM	220V - 50 HZ 1.8A - 390W	38 TURNS	12 5.5	586	265	440	200	352	160
PH 30/14*	265	30	14 RPM	120V - 60 HZ 2.7A - 320W	38 TURNS	12 5.5	353	160	265	120	210	95

### ACCESSORIES

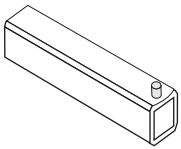
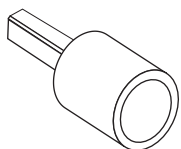
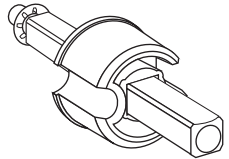
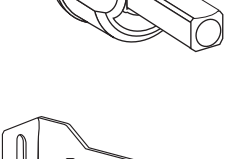
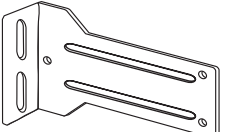
	CAT. NO.	DESCRIPTION
	6090218	Adaptor Sleeve 19mm square to 13mm square. Compatible with ref. - 6090094 and 6090106. Material - cast aluminum.
	6090263	Phoenix 19mm Square Drive Adaptor fits directly into motor shaft. Tubular Dimensions - 36.5mm OD x 28.25 ID. Material - zinc plated steel
	6090094	Drive End Cap with 13mm square shaft/ 12mm O.D. for 2" x 1.86: I.D. tube
	6090106	Same as Above for 2.5" x 2.37" I.D. Tube. Material: End Cap - cast aluminum. Shaft - zinc plated steel
	6070250	Heavy duty angle plate bracket with 2 M6 screws. Material - steel with durable paint finish

\* -UR AND CSA CERTIFIED

## PHOENIX PH 30/14 (110V AC)

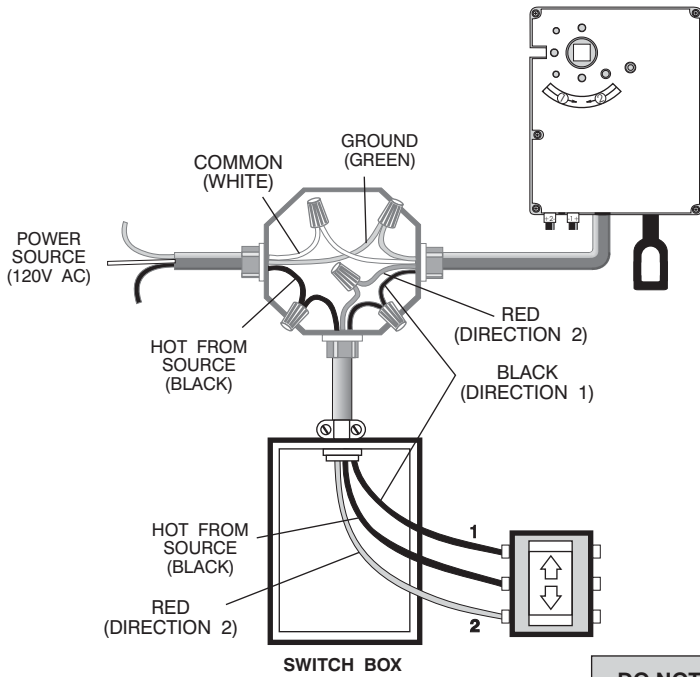

## PHOENIX PH 50/12 (220V AC)

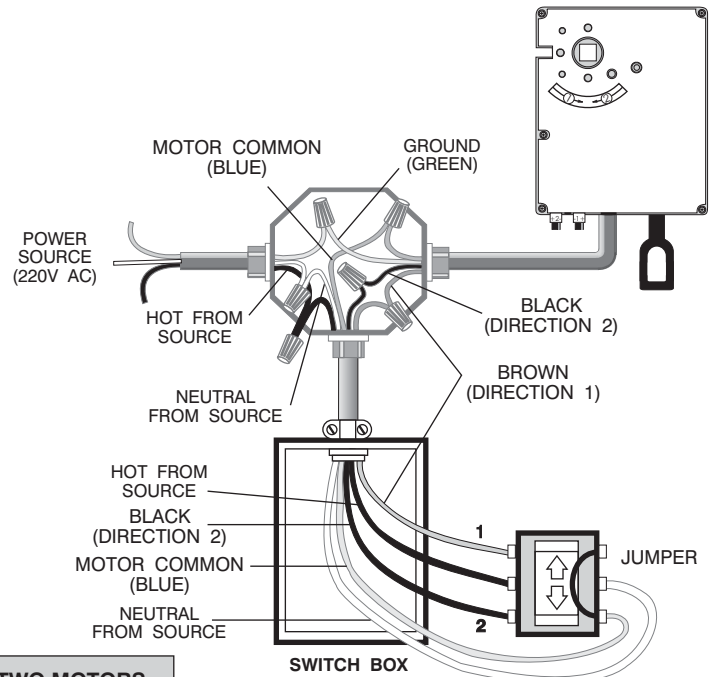

**DO NOT WIRE TWO MOTORS TO ONE SINGLE POLE SWITCH (DO NOT WIRE IN PARALLEL)**

**ALL WIRING MUST BE IN ACCORDANCE WITH N.E.C. AND LOCAL CODES**

### MOTOR WIRING COLOR CODE

PH 30/14 110 VAC	CODE
BLACK	1:DIRECTION
RED	2:DIRECTION
WHITE	COMMON
GREEN	GROUND

### SUGGESTED SWITCHES

	CAT. NO.
Maintained Rocker Switch (princess plate)	6120144
Momentary Rocker Switch (princess plate)	6120155

### MOTOR WIRING COLOR CODE

PH 50/12 220 VAC	CODE
BROWN	1:DIRECTION
BLACK	2:DIRECTION
BLUE	COMMON
GREEN	GROUND

## LIMIT SWITCH SETTING

### 1. CHECK TO ENSURE THAT YOUR AWNING (or other window covering) IS MOVING IN THE RIGHT DIRECTION.

After wiring the Phoenix motor, turn the power on to ensure that the switch is operating properly.

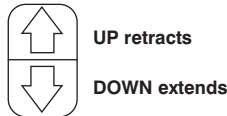

**If not,**

turn the power off, and simply reverse the black and red (or brown and black) motor leads connected to the switch.

### 2. SETTING THE LIMIT SWITCHES.

- Check the arrow directions near the hollow square drive shaft.

- The UP and DOWN motor limits are set by the two socket screws located near the manual override hook. Please use for this purpose the Allen wrench included with the motor.

### Setting the "up" position

- Press the switch in "up" position.
- If the system stops before its Up limit, turn the UP screw to "+" until necessary.
- If the system does not stop before its Up limit, press the switch in "DOWN" direction and turn the UP screw to "-". Repeat this until correct setting is realized.

### Setting the "DOWN" position

- Press the switch in "DOWN" direction.
- If the system stops before its Down limit, turn the "DOWN" screw to "+".
- If not, press the switch in "UP" direction and turn the DOWN screw to "-". Repeat this until correct setting is realized.

- Screw 1 adjusts direction 1
- Screw 2 adjusts direction 2

