

### Description

- The Altus RTS is designed for rolling blinds, awnings, and shutters.
- It features an integrated radio receiver with remote limit setting and remote user programmable intermediate stop.
- The Altus RTS radio receiver (433.42 MHz) must be programmed with the Inteo family of transmitters.
- The Altus RTS motors are compatible with SOLIRIS and EOLIS RTS Sensors.

### Important Installation Tips

- For initial programming provide power only to the motor being programmed.**
- All motor feedback (previously audible "beeping") is now replaced by a visual jog. A jog is a short Up & Down movement of the motor (0.5 second turn of the motor in each direction).**
- The ALTUS RTS motor in Factory Mode will not respond to any transmitter (as it did previously with RTS Motors) until a transmitter is assigned to communicate with the motor's receiver. To assign a transmitter press its Up & Down buttons simultaneously until the motor jogs.
- Before pressing the programming button on the transmitter, verify the motor directions (if DOWN on the transmitter corresponds to DOWN on the end-product) and set (program) the end limits of the motor. Refer to section 4.3 of this instruction.
- The motor is packaged in "FACTORY MODE", and will remain in this mode until the limits are set and the programming button on the transmitter is pressed, thus putting it into "USER MODE". ROTATION DIRECTION CAN ONLY BE MODIFIED IN "FACTORY MODE".
- A double power cut cannot be achieved if the motor is still in FACTORY or INSTALLER mode. First program a transmitter into the memory of the motor.
- WARNING: For the EOLIS/SOLIRIS RTS SENSOR to function properly, the transmitter which is memorized into the motor's receiver must be configured correctly. The DOWN button MUST correspond to DOWN on the end-product. In the case of an awning, it will open or extend the awning. If the UP button extends the awning, the wind sensor will also extend the awning during windy conditions. THIS IS DANGEROUS! Damage and injury could occur. Do not proceed until proper operation of the transmitter is verified.**
- The ALTUS RTS motor must be installed in the tube required for the particular application because the electronic speed variance detection will not allow the motor to turn if the crown does not rotate.

## 1 Power Supply 120 VAC / 60 Hz

- All wiring must conform to NEC (National Electrical Code) and local codes.
- The ALTUS RTS motors can be wired in PARALLEL.  
A means of disconnecting the power at each motor independently should be provided.
- Power only needs to be supplied to the motor. The receiver is completely enclosed inside the motor tube.
- The external antenna will be phased out and become internal to the motor.
- SOMFY Reserves the right to void the motor warranty if wiring recommendations are not followed.**

#### MOTOR WIRING COLOR CODE

120 VAC	CODE
BLACK	HOT
WHITE	NEUTRAL
GREEN	GROUND

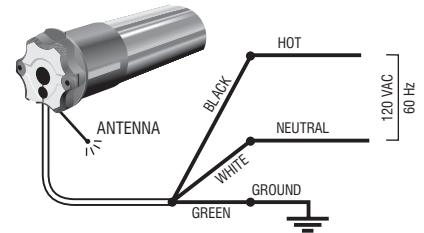

## 2 Transmitters

*Pictured below are all compatible controls*

- Motor's memory capacity with Telis, Decora RTS, Telis Soliris: maximum of 12 transmitters plus and additional 3 RTS sensors.
- The Master Channel on a 4 channel transmitter can be used as an additional individual channel for a total of 5 channels, without the option of master control of all motors
- Range: Up to 65 feet from the motor

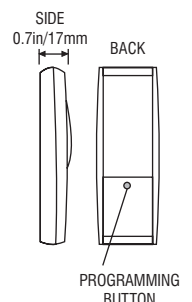
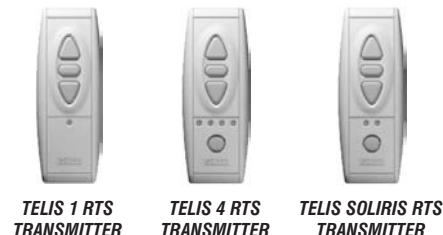
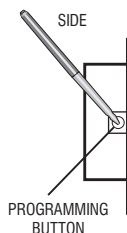
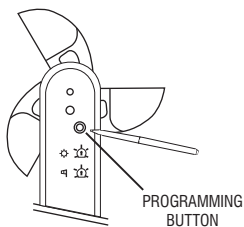
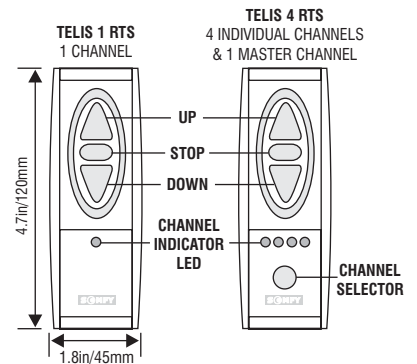

# 3 Installation Requirements

- If the installation is made up of several RTS motors, only one RTS motor must be powered during programming. All other motors must be disconnected. This will avoid interferences during the initial programming of each motor.
- The mounting distance between 2 motor heads should not be less than 19 inches between RTS motor heads, to avoid possible interference.
- Use only SOMFY RTS radio controls.
- In order to avoid water penetration, form a "drip loop" with the power cable and use hood when required.
- Use SOMFY accessories (adaptors, brackets, plug ends,...), rated for the motor torque and total weight of the installation.

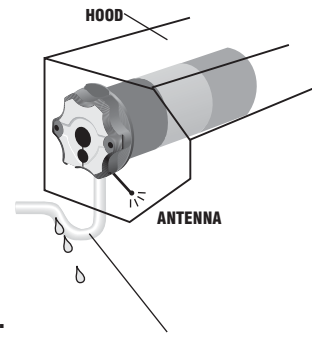

The motor cable should not act as a direct conduit for the water to enter the head of the motor (form drip loops).

**NOTE: SOMFY motors conform to IP44 requirements and as such must be protected against direct weather elements such as rain, sleet,...etc.**

# 4 Factory Mode

*This mode allows for rotation direction modification and setting of the end limits*

## CONTROLLING THE ALTUS RTS MOTOR WHEN SWITCHING POWER ON FOR FIRST TIME

- 1) The ALTUS RTS motor must be installed in the tube required for the particular application because the electronic speed variance detection will not allow the motor to turn if the crown does not rotate. Provide power to the motor. Notice the motor will not respond to any transmitter until a transmitter is assigned to communicate with the motor's receiver.
- 2) To assign the transmitter to communicate with the motor's receiver, push the UP and DOWN buttons on the transmitter SIMULTANEOUSLY. The ALTUS RTS motor records the address of this transmitter, and only this activated transmitter can be recorded into the memory of the ALTUS motor. This prevents other transmitters from being recorded during factory assembly environments.

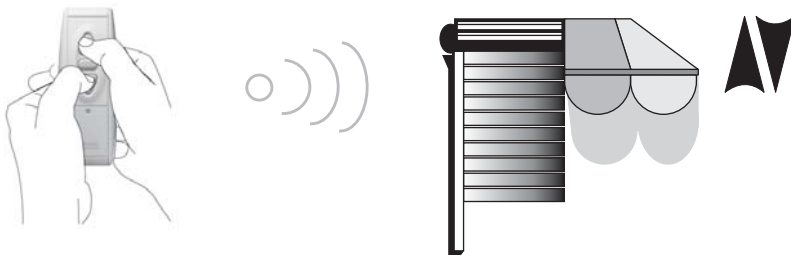

Release the buttons after the end-product jogs briefly UP/DOWN indicating that this transmitter can operate the motor during programming. The ALTUS RTS motor will now operate in a momentary fashion

\* In case of problems with FACTORY MODE, turn the power off to the motor for 2 sec. and then back on in order to reset it. (EXAMPLE: If the ALTUS motor is powered and a different transmitter activates the motor which is not the intended transmitter to be used for limit setting, then perform a single power cut. This will delete the address currently in memory and allow your transmitter to be activated.

- 3) Check direction of operation. The DOWN button must correspond to DOWN on the end-product. In the case of an awning, it will open or extend the awning. If the direction is wrong, change the direction as shown.

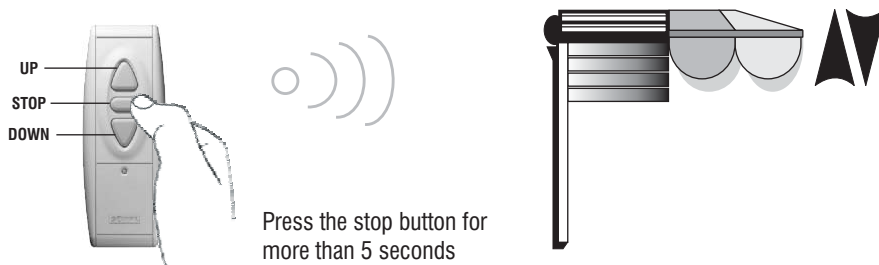

Press the stop button for more than 5 seconds

Release the STOP button when the end-product jogs briefly UP/DOWN indicating that the change has been memorized in the motor. Verify if the change took place before proceeding.



**WARNING:** For the **EOLIS/SOLIRIS RTS SENSOR** to function properly, the transmitter which is memorized into the motor's receiver, must be configured correctly. The DOWN button MUST correspond to DOWN on the end-product. In the case of an awning, it will open or extend the awning. If the UP button extends the awning, the wind sensor will also extend the awning during windy conditions. **THIS IS DANGEROUS!** Damage and injury could occur. Do not proceed until proper operation of the transmitter is verified.

4) Adjust the end product to the up position. This is necessary to establish a reference starting point. Read the complete limit setting procedure before proceeding with setting the UP and DOWN limits.

### 5) Setting of the END LIMITS

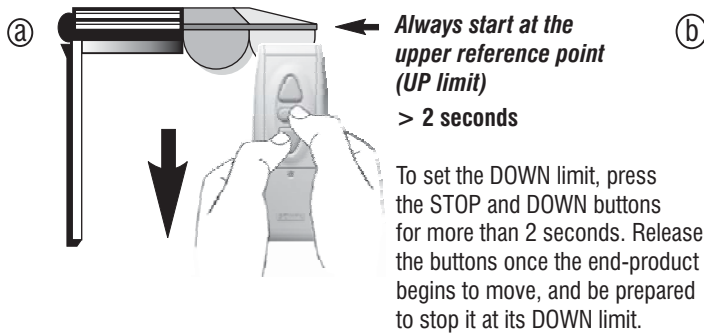

The end-product moves towards the DOWN limit.

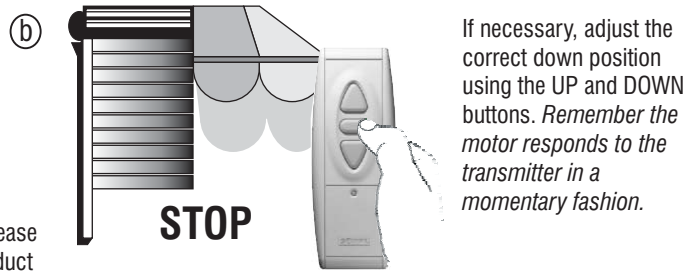

Stop the motor at the desired DOWN limit

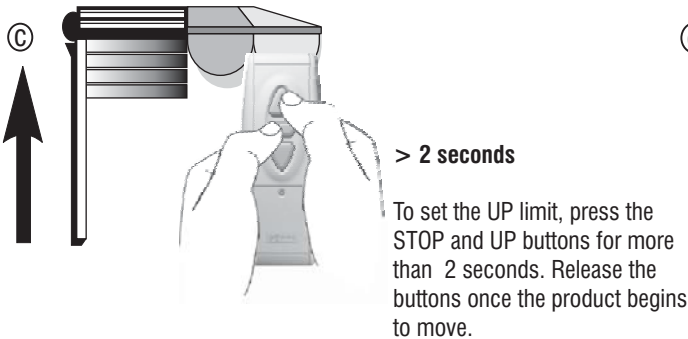

The end-product moves up and will stop at its upper reference point (UP Limit)

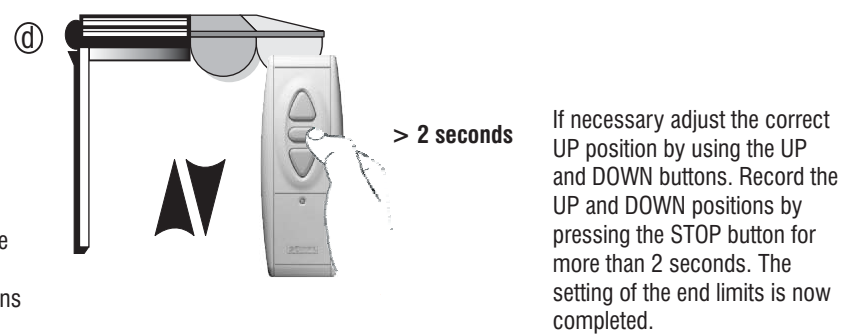

The application jogs briefly UP/DOWN indicating that the UP and DOWN position have been memorized in the motor. The motor is now in **INSTALLER MODE**.

#### **HELPFUL HINTS:**

1. Once the end limits are confirmed during **FACTORY MODE**, it is possible to delete the limits and start over at the beginning. - Just press UP & DOWN simultaneously for 2 sec. until the motor jogs. This deletes the limits and starts you at the beginning of Factory Mode.
2. If the ALTUS motor is still powered after confirming the limits, only this activated transmitter/channel can be recorded by pressing the programming button (this prevents other transmitters from being recorded during factory environments).
3. The only way to record a different transmitter/channel is to perform a single power cut in **INSTALLER MODE** (which is right after both limits have been confirmed). Then press any transmitter button (UP, STOP or DOWN) independently to activate this transmitter's address into the memory of the motor. The first transmitter you activate will only respond, unless you perform another single power cut. Then press the programming button to record this new transmitter/channel.

## 5 Installer Mode

*This mode allows for readjusting of the end limits and final programming*

#### **IMPORTANT**

If the installation is made up of several ALTUS RTS motors, only one ALTUS RTS motor must be powered during programming. This will avoid interference with the first programming of each ALTUS RTS motor. If several motors are connected on the same power supply please refer to the Warning note in Section 6.5 "Resetting motors back to USER MODE".

**\*If the INSTALLER MODE directly follows FACTORY MODE, with no power interruption to the motor, go directly to Section 5.2**

1) Provide power to the ALTUS RTS motor. Press UP, STOP or DOWN *independently* on any transmitter in order to take control of the motor. Check that the ALTUS RTS motor is in INSTALLER MODE.

In this mode the ALTUS RTS motor runs when a directional button on the transmitter is pressed and held (momentary fashion), and the ALTUS RTS will stop at its preset end limits.

**NOTE:**

If you do Press the UP & DOWN transmitter buttons simultaneously after a single power cut, then you will lose the confirmed limits and enter FACTORY MODE with this new transmitter/channel already activated.

2) Recording the first Transmitter or Channel. On 4 channel transmitters select the desired channel before pressing the programming button.



Press the programming button on the RTS transmitter



Release it when the end-product jogs briefly UP/DOWN indicating that the transmitter has been memorized into the motor

3) Readjusting of the UP or DOWN limit after the transmitter has been programmed.

a) Modify the DOWN or awning extended limit first. Using the transmitter bring the product to the DOWN limit.

The motor must reach the DOWN limit and stop on its own.

b) Follow the steps below.



5 Seconds



Press for more than 5 Seconds on the UP button and the DOWN button simultaneously



Release the buttons after the end-product jogs briefly UP/DOWN indicating that the motor is in the "END LIMIT SETTING STATE".

c) Adjust the DOWN limit to the new position (the motor will respond to the transmitter in a momentary fashion).

d) Record the new DOWN limit.



>2 Seconds



Press the STOP button for more than 2 seconds

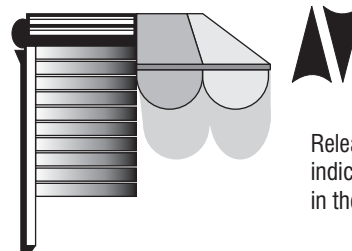

Release after the awning jogs briefly UP/DOWN indicating that the change has been memorized in the motor.

e) The new DOWN or extended limit has been recorded. Repeat the same procedure for the UP or retracted limit.

# 6 User Mode

*This mode is for operating the motor by the end user*

**One Intermediate Position (IP) can be programmed into the ALTUS RTS. No reference point is necessary due to the electronic limit switch. The IP can be reached from any point between the end limits.**

## 1) Intermediate position (IP)

### RECORDING THE INTERMEDIATE POSITION

Adjust the intermediate position by using the UP, DOWN, and STOP button on your control. The ALTUS motor must be in stop position before programming.

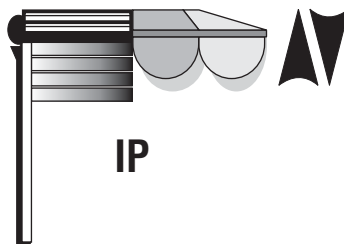

Release it after the end-product jogs briefly UP/DOWN indicating that the intermediate position has been memorized in the motor

### USING THE INTERMEDIATE POSITION

Manually: Press the intermediate button (STOP button) when the motor is not in motion

Automatically: When the SOLIRIS RTS sensor reaches the set DAYLIGHT THRESHOLD, it gives a DOWN command. The end-product will move to the intermediate position only if the intermediate position has been programmed. Otherwise it will move to the DOWN limit.

### TO DELETE THE INTERMEDIATE POSITION

Reach the intermediate position. Then press on the STOP button and hold it (approx. 5 sec.) until the end-product jogs briefly. The IP has been deleted.

## 2) Add or Delete a transmitter/channel in the memory of ALTUS RTS motor. The procedure is the same for adding or deleting a transmitter/channel. If the transmitter/channel has not been previously memorized it will be added instead of deleted.

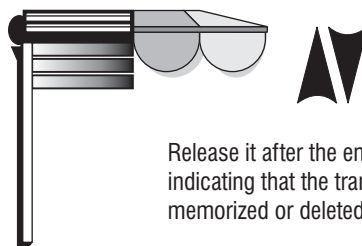
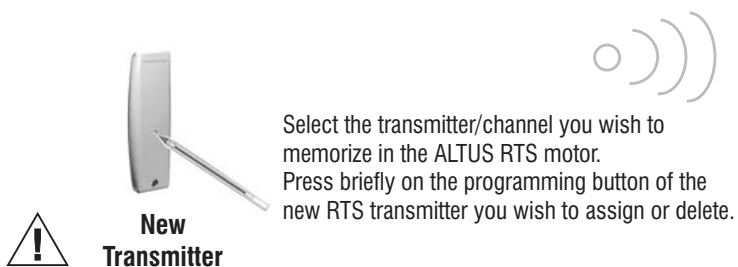
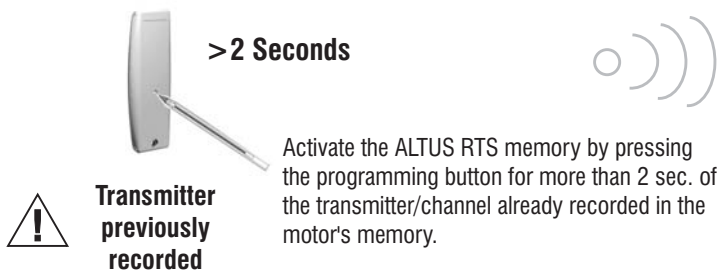

**Repeat this procedure for each additional transmitter/channel you wish to add or delete. It is not possible to delete the transmitter/channel used to enter the programming state.**

### 3) Add or Delete an EOLIS or SOLIRIS Sensor RTS in the memory of ALTUS RTS motor

#### a) Enter the "PROGRAMMING STATE"



**>2 Seconds**

Press the programming button (for more than 2 seconds) of the RTS transmitter/channel which is already recorded in the motor.

**Transmitter previously recorded**

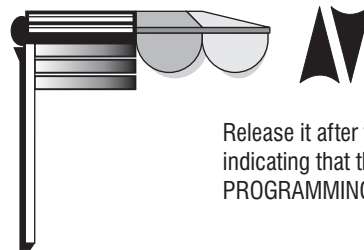

Release it after the end-product jogs briefly UP/DOWN indicating that the ALTUS RTS motor is in a PROGRAMMING STATE.

#### b) Record or delete a sensor

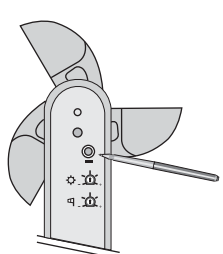

Press BRIEFLY on the programming button of the RTS sensor.

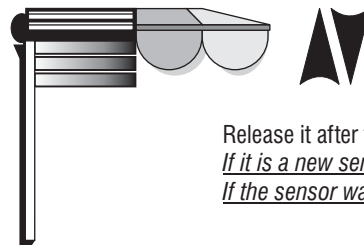

Release it after the end-product jogs briefly UP/DOWN  
*If it is a new sensor: it will be recorded into the motor.*  
*If the sensor was previously recorded: it will be deleted.*

#### c) Erase all the sensors and record a new one

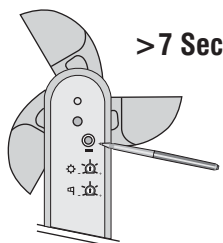

**>7 Seconds**

Press for more than 7 SECONDS on the programming button of the new RTS sensor.

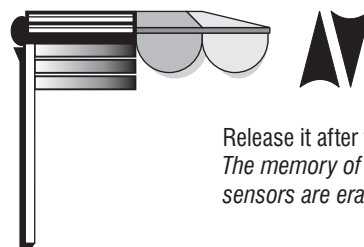

Release it after the end-product jogs briefly UP/DOWN  
*The memory of the receiver is cleared (all the previous sensors are erased) and the new sensor is recorded.*

### 4) Resetting the motor's memory (recording a new transmitter when the original transmitter is lost.)

**\*\*A.** Perform a power cut in the following sequence:

1. Power-off - 2 sec. minimum
2. Power-on - 5 to 15 seconds
3. Power-off - 2 sec. minimum
4. Power-on

The end product moves for 5 seconds in one direction, to indicate that the double power cut has been recorded. The motor is in a PROGRAMMING STATE for 2 minutes. Proceed to STEP B or C depending on the desired result.

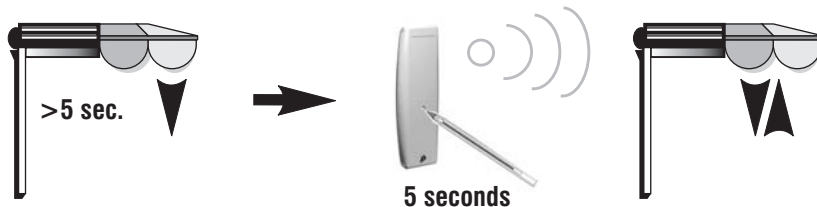

### NEW TRANSMITTER

#### **B. RECORDING A NEW TRANSMITTER** (after losing the 1st transmitter)

Press the programming button of the NEW RTS transmitter, for 1 second max. Release it after the end-product jogs briefly UP/DOWN indicating that the transmitter has erased all previous transmitters and recorded the NEW one.

#### **C. RESTORING FACTORY MODE**

(with a new transmitter after losing the 1st one)

Press and **HOLD** the programming button for more than 7 seconds of the NEW RTS transmitter. The end-product will jog briefly UP/DOWN twice. Once after 1 second and again after 7 seconds. This indicates the ALTUS RTS motor has been completely cleared.

#### **\*\*RESETTING MOTORS BACK TO USER MODE**

**WARNING:** This type of power cut affects all the ALTUS RTS motors on the same power line. To avoid resetting of non-concerned motors, press briefly any button of their assigned transmitter. (UP, STOP, or DOWN) The non-concerned motors will return to USER MODE.

**NOTE:** A double power cut cannot be achieved if the motor is still in FACTORY or INSTALLER mode. First program a transmitter into the memory of the motor.

## 5) Back to the factory configuration (to reset the ALTUS RTS motor memory using a previously recorded transmitter)

**\*\*A.** Perform a power cut in the following sequence:

1. Power-off - 2 sec. minimum
2. Power-on - 5 to 15 seconds
3. Power-off - 2 sec. minimum
4. Power-on

The end product moves for 5 seconds in one direction, to indicate that the double power cut has been recorded.

The motor is in PROGRAMMING STATE for 2 minutes.

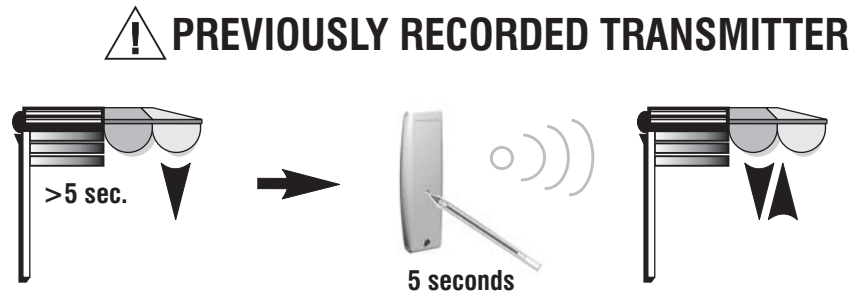

### B. RESTORING FACTORY MODE

Press and **HOLD** the programming button for more than 7 seconds of the NEW RTS transmitter. The end-product will jog briefly UP/DOWN twice. Once after 1 second and again after 7 seconds. This indicates the ALTUS RTS motor has been completely cleared.

**NOTE:** A double power cut cannot be achieved if the motor is still in **FACTORY** or **INSTALLER** mode. First program a transmitter into the memory of the motor.

#### **\*\*RESETTING MOTORS BACK TO USER MODE**

**WARNING:** This type of power cut affects all the ALTUS RTS motors on the same power line. To avoid resetting of non-concerned motors, press briefly any button of their assigned transmitter. (UP, STOP, or DOWN) The non-concerned motors will return to USER MODE.